

THE URBAN ELECTRIC C<sup>o</sup>.

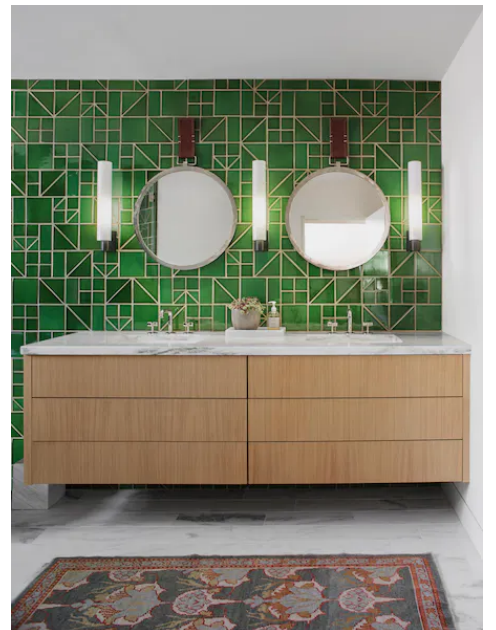

MAISON

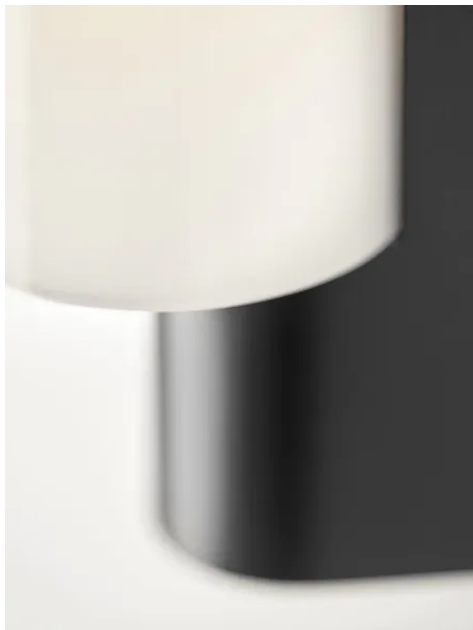

# MAISON

WALL SMALL

MA-1590WS

## DIMENSIONS

Width	3.25in
Height	14.5in
Depth	4.5in
X	2.5in
Y	12in
Z	3in

## MOUNTING

Recommended Installers	1
Weight	3lbs
Backplate	3.25in x 4.75in
Junction Box	2in x 4in rect

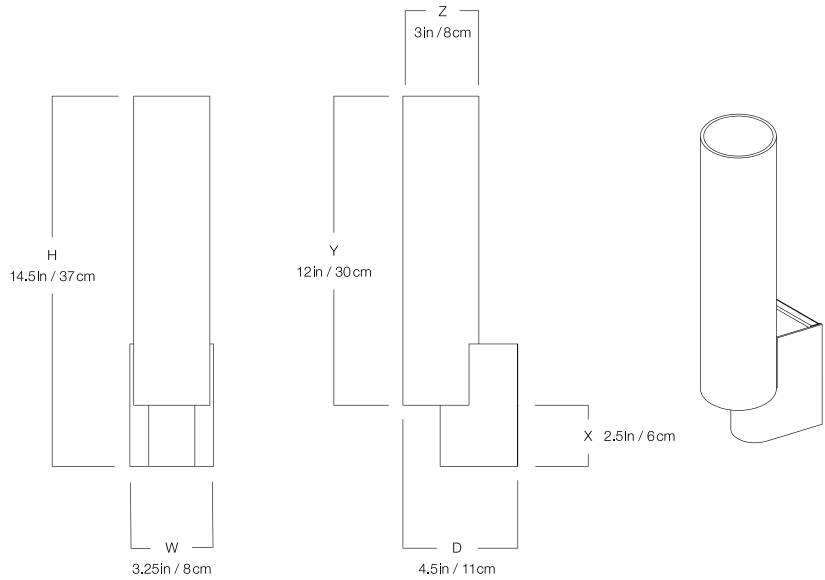
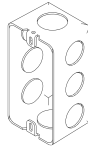

## LAMP / WIRING

Max Wattage (1) 60W C

Ships with complimentary LED bulb



## RATING

Suitable for DAMP locations

UL Listed



## PATENTS

This fixture is Patented with the United States Patent and Trademark Office. Patent No. D821,628 June 26, 2018

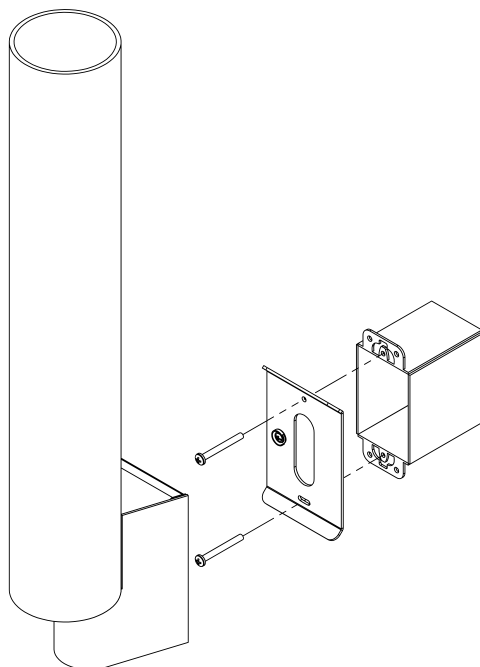

# MAISON

WALL REGULAR

MA-1590WR

## DIMENSIONS

Width	3.25in
Height	20in
Depth	4.5in
X	2.5in
Y	17.75in
Z	3in

## MOUNTING

Recommended Installers	1
Weight	5lbs
Backplate	3.25in x 4.75in
Junction Box	2in x 4in rect

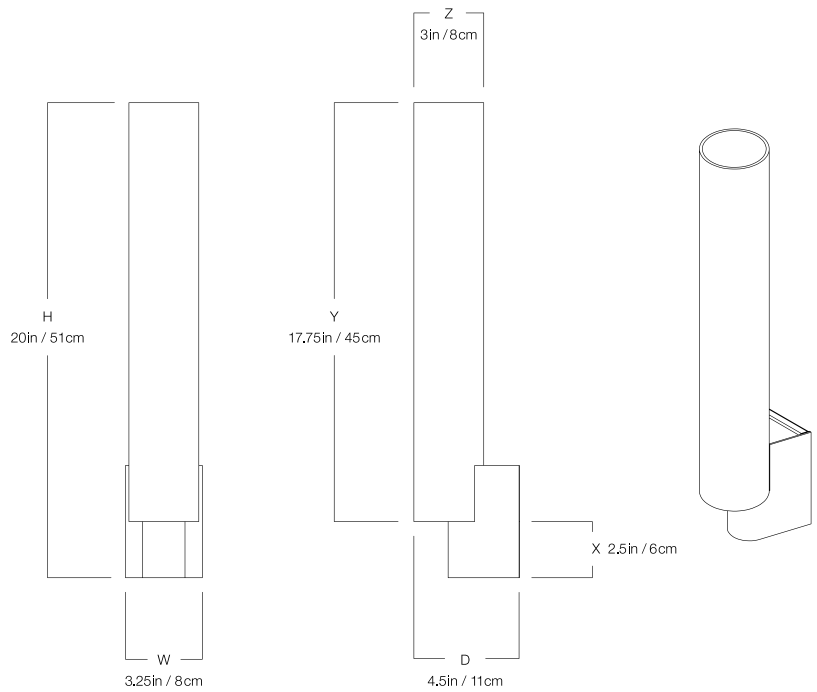
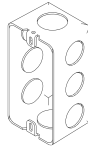

## LAMP / WIRING

Max Wattage	(1) 60W C
Ships with complimentary LED bulb	



## RATING

Suitable for DAMP locations

UL Listed



## PATENTS

This fixture is Patented with the United States Patent and Trademark Office.  
Patent No. D821,628 June 26, 2018

